

WELDING PRESSURE PIPELINES & PIPING SYSTEMS



Procedures and Techniques

LINCOLN[®]
ELECTRIC

THE WELDING EXPERTS

Table of Contents

| | |
|--|--------|
| Introduction | .3 |
| Vertical Down vs. Vertical Up | .3-4 |
| Cross Country Pipeline-Vertical Down Welding | |
| Joint Preparation | .4 |
| Pipe End Cleaning | .4-5 |
| Welding the Root Pass | .5-6 |
| Current Settings w/Lincoln Engine Driven Welders | .6-7 |
| Root Pass Welding | .7 |
| Root Pass Troubleshooting | .7 |
| Techniques for Welding Hot Pass | .8 |
| Techniques for Welding Fill and Cap | .8 |
| Setting the Current etc. | .8-9 |
| Preventing Cracking | .10 |
| Techniques for X60 etc. | .10-11 |
| Vertical Down Procedures | .12-13 |
| Electrode Consumption | .14-15 |
| Thin Wall Pipe Welding Procedures | .16-20 |
| Double Ending | .20-21 |
| Flux & Electrode Selection | .21 |
| API Pipe Steel | .22-24 |
| Consumables for Welding Pipe | .25 |
| Consumables for High Strength Pipe | .26 |
| Consumables for SMAW | .27-30 |
| Consumables for FCAW | .30 |
| Consumables for GMAW | .31 |
| Pipe Welding Electrodes | .32-33 |
| Mechanical Properties | .34-35 |
| In-Plant Pipe | .36-37 |
| Pipe Axis - Horizontal & Vertical | .38 |
| Vertical Up Welding | .39 |
| Vertical Up Electrode Consumption | .40-41 |
| ASTM Pipe Steels | .42-43 |

Introduction

This booklet is a guide to welding pipe with Shielded Metal Arc Welding (SMAW) and double ending pipe using automatic welding. Lincoln Electric supplies electrodes, power sources, automatic and semiautomatic wire feeders, submerged arc wire and flux, which are the industry standards for pipeline construction around the world.

Semiautomatic, self-shielded flux-cored Innershield® Process is being used around the world to produce high quality, low hydrogen, reliable, lower cost pipeline welds.

Vertical Down vs. Vertical Up Welding

Vertical down welding with cellulosic electrodes is normally done with high currents and high travel speeds. Cellulosic electrodes have a thin coating containing a large amount of organic cellulose. When the electrode is burned, the coating forms a protective gas coating for the molten metal. Because of the organic material and the moisture content of these electrodes, they have a very strong arc force but at the same time the weld metal freezes very quickly. This method of welding is fast and economical, consequently most cross country pipelines are welded with the progression vertically downward. Impact toughness properties, which are very good may be met with modern cellulosic electrodes.

Vertical up welding with either cellulosic electrodes or low hydrogen electrodes is done with relatively low currents and low travel speed, which produce joints with relatively few, but large beads.

With low hydrogen vertical up electrodes, welds may be made virtually free of slag entrapment and porosity. These welds are best able to meet strict radiographic requirements for high pressure, high temperature or low temperature piping. Because of the low hydrogen deposit, susceptible to

CROSS COUNTRY PIPELINE

Vertical Down Welding

Joint Preparation

The joint preparation usually used for cross country pipeline is from API 1104 code. As shown in the figure below, the normal situation is a “penny land, penny gap”, meaning that the land (root face) on the pipe should be ground to approximately the thickness of a penny [1/16” (1.6mm)]. The gap between pipes should be the same distance, if possible. A 60° Included angle is used.

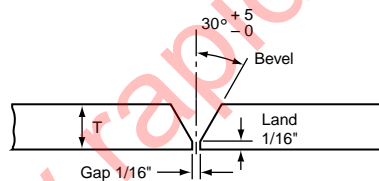

Pipe End Cleaning

Pipe rarely will be received in a condition suitable for welding. Generally, there will either be an oil or rust coating, or a coating to prevent corrosion. This could include paint, primer, varnish, epoxy, tar paper, or any variety of organic substances, all of which are undesirable for welding. **Cleanliness is critical to prevent defects leading to rejected welds and costly repair, so these coatings must always be removed.**

The following are the guidelines to minimize welding defects related to surface contamination:

- **Moisture and condensation must always be removed prior to welding.**
- **Both pipe ends must be cleaned, on the inside and the outside, at least 1" (25mm) beyond the edge of the bevel.**
- **One recommended means of cleaning pipe is with a straight shaft grinder with a rubber expanding wheel and carbide coated sleeve. A sanding disc can also be effective, as well as an abrasive grinding disc.**
- **Depending on the pipe size, a half round file can be used to remove any burrs created when the end is ground on to the end of the pipe.**

Welding the Root Pass

Before beginning to weld the pipe, the procedure should be checked to assure that the correct electrode is being used. This includes the diameter and the classification of the electrode. The welding consumable should be selected to correctly match (or overmatch) the strength of the pipe.

Either Fleetweld[®] 5P or Fleetweld 5P+ should be used for stringer bead and the hot pass when the hardness of the root pass is a concern, even if other higher strength consumables are to be used to fill and cap the weld. This "softer" root increases the resistance to certain types of weld cracking.

A number of factors will determine how many welders will be needed to weld the root pass. In any case, it is best to have welders either (1) weld opposite one another or (2) evenly spaced around the pipe. This will minimize the amount of distortion in the pipe and prevent the gap from opening or closing. If possible, it is also desirable not to finish a weld in exactly the bottom of the pipe because the tie-in can be more difficult. Similarly, it is best to avoid starting at exactly the top of the pipe (12 o'clock position).

As a rule of thumb, for a 5/32" (4.0mm) electrode, on the welding time for one electrode should be approximately one minute and the length of weld should be approximately the same as the length of electrode consumed. This would produce a travel speed of approximately 12 inches per minute, but this is extremely sensitive to joint preparation and exact welding conditions.

The root pass is welded with a "drag" technique. The tip of the electrode is held in contact with both pipes and dragged around the circumference of the pipe, progressing vertically downward. The electrode initially should be held roughly perpendicular to the pipe. If there is a proper fit-up and the proper current is used, a small "keyhole" will be

seen following behind the electrode. If the keyhole is not seen, the electrode is not penetrating through to the inside of the pipe. The remedies for this would be:

- Higher current.
- Apply more pressure on the electrode which lowers voltage and yields a colder puddle (depending on the type of welding machine).
- Use a push angle (although this is not always advisable).
- Slower travel speed.

If the keyhole becomes too large and difficult to control, the remedies would be:

- Lower the current.
- Travel faster until the size of the keyhole decreases.
- Use more of a drag angle while using faster travel speed until the keyhole becomes more manageable.
- Apply less pressure on the electrode which creates a bigger keyhole.

The required current decreases as the gap size increases. If the gap is too narrow, it is not unusual to push so hard on the electrode that a 5/32" (4.0mm) electrode will bend.

Sometimes, because of magnetic conditions the arc will tend to push to one side of the joint. This is called *arc blow*. There are two solutions to this *while welding*:

- 1) Put side pressure on the electrode opposing the arc blowing tendency. This will cause the coating to burn more even, and equalize the burnoff and tie-in equally.
- 2) While continuing to weld, point the electrode to counter-act the arc blow. This is the less desirable method because it can lead to internal undercut defects.

Current Setting with Lincoln Engine Driven Welders

The following recommendations are based on the following assumptions:

- Welding is done in the vertical down (5G or 6G) position.
- The root pass is made with a 5/32" (4.0mm) diameter electrode.
- A cellulosic electrode (E-XX10) is being used.
- The root pass is welded with reverse (DC+) polarity.
- The hot pass is made with a 5/32" (4.0mm) diameter electrode.
- The fill pass is made with a larger diameter 3/16" (5.0mm) electrode.
- The joint has been carefully prepared to API specifications (1/16" land, 1/16" gap and 60° included angle).

The joint fit-up will rarely be perfect, so the following recommenda-

tions should be used ONLY as a starting point. The welder's skill and the characteristics of their machine and the joint conditions will all contribute to variations from the recommended set points. The settings given on page 8 are intended **only** as starting points.

For reverse DC polarity, the current control should be set as high as necessary while the open circuit voltage (OCV) is set as low as possible to prevent negative arcing on the electrode. In practice, it is not obvious by looking at the dials on the machine how to accomplish this.

Root Pass Welding

| Welder | Range Control Setting | Fine Control Setting |
|---|---|--------------------------------|
| Pipeliner® 200G Classic II Classic 300G Classic 300D SA-250 | <i>Current Range Selector</i> | <i>Fine Current Adjustment</i> |
| | 240-160 (or) 190-120 | ~30 40 |
| | <i>Variable Voltage Control</i> | <i>Current Control</i> |
| | 5 | 100 - 150 |
| SAE-400 | <i>Job Selector</i> | <i>Current Control</i> |
| | Lower end of Overhead & Vertical Section | ~150 |
| Commander™ 300 Commander 500 | <i>Process & Range Selector</i> | <i>Output Control</i> |
| | 250 Max. | 6 - 7 |

In each case listed above, with the proper fit-up, the current with a 5/32" (4mm) diameter electrode will be in the neighborhood of 130 amps. From this point, the current should be changed according to the individual welder's skill and needs. In the United States, root pass welding is usually done with r locations straight polarity (DC-) is faster than positive therefore travel speed should be faster and internal undercut and hollow bead defects are less likely. DC- (straight) polarity is also advisable for thin wall pipe to prevent burn through.

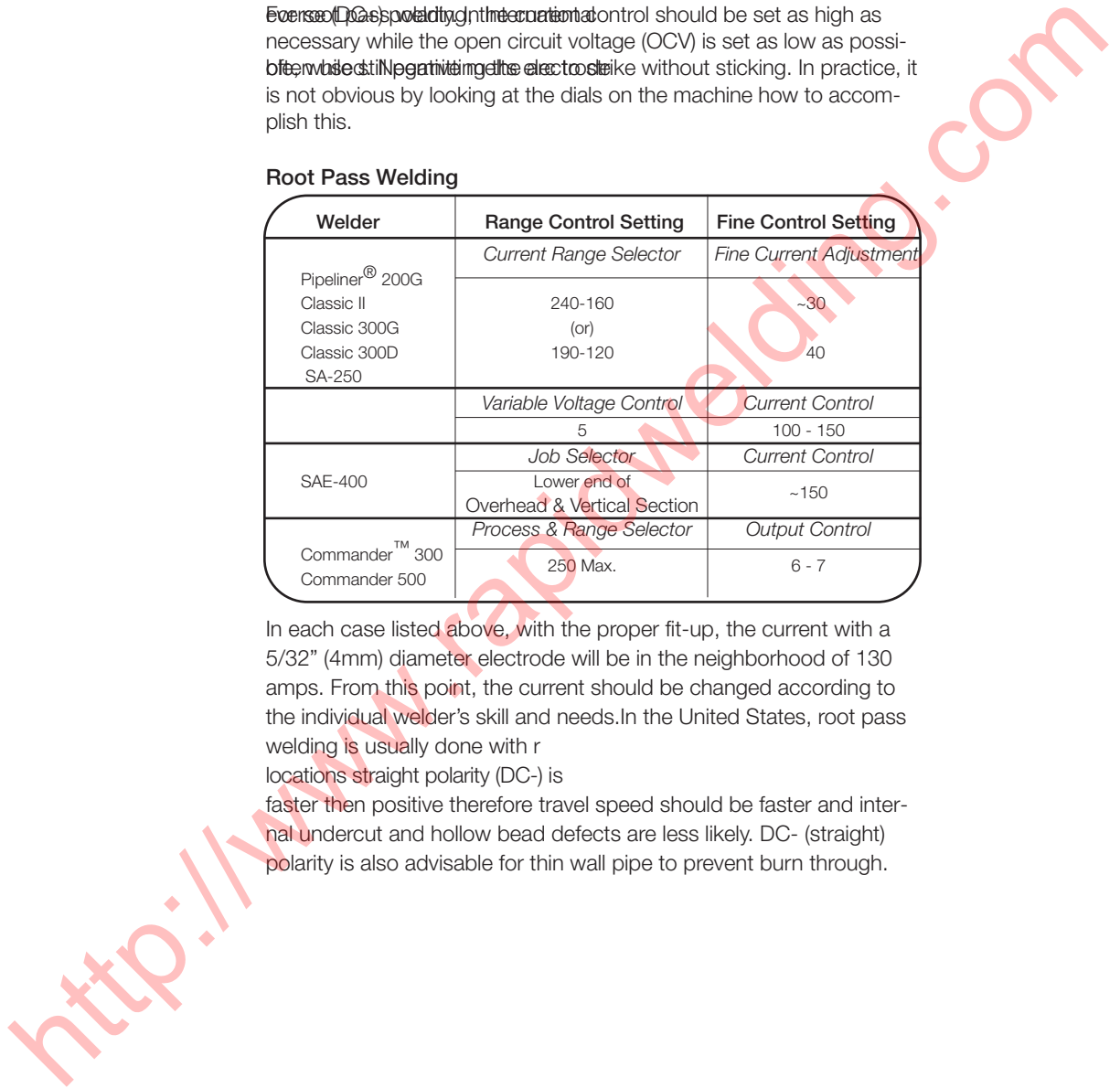

Techniques for Welding Hot Passes

After the root pass is welded, the root bead is generally very convex on the exterior of the pipe. The normal procedure is to grind the root pass to eliminate the excessive convexity. Normally, the entire weld is not ground out, rather only enough to expose "wagon tracks". These are lines of slag that are on either side of the built up convex region.

The purpose of the hot pass is primarily to burn out the "wagon tracks". Ideally, this is achieved leaving the joint free of undercut and some filling of the joint is also accomplished. To do this, a high current is normally used. With 5/32" (4.0mm) cellulosic electrodes, a current of 160 - 200 amps is normally used, but using higher current values, the electrode can overheat. Larger (3/16" diameter) electrodes can also be used, with currents around 180 amps. Larger electrodes have a tendency to fill rather than dig.

Techniques for Welding Fill and Cap Passes

The exact procedure for welding fill and cap passes is dependent on the characteristics of the pipe (wall thickness, temperature, and position on the pipe), the skill of the welder, as well as the characteristics of the welding machine. With SMAW stick electrodes, the idea is normally to fill the joint as quickly as possible. When welding vertically down, higher currents may be used than vertical up welding, so the melting rate of the electrode is greater and the joint can be filled in less time. Additionally, the usual practice is to use a larger diameter electrode for the fill passes than what had been used for the root and hot passes [3/16" (5.0mm) electrode when 5/32" (4.0mm) electrodes were used for the root and hot passes].

In critical applications for low temperature service, it may be necessary to maximize the impact toughness properties of a weld. In this case, one technique is to split the layers into 2 passes as soon as possible. *The objective is to align fine-grained reheated zones along the centerline of the weld, where the test samples are taken.* Fill passes should continue until the joint is filled to flush or slightly below flush with the pipe. If the beveled edges of the joint are visible, the cap pass(es) can be welded more easily.

The cap pass should be welded at lower currents than the fill passes [as low as 140 amps with a 3/16" (5.0mm) electrode].

Setting the Current for Hot Pass, Fill Pass, "Stripper Pass" and Cap Pass Welding

The purpose for the hot pass is to melt and float out the wagon tracks left after the root pass. The current, therefore, should be high enough to burn out the slag, but not so high as to burn a hole through the root pass.

The root pass should be thoroughly cleaned before welding the hot pass. This is typically done with a disc grinder, which not only cleans

out the slag, but also flattens the contour of the bead before the hot pass is welded. If this grinding operation is not done, there is a greater chance that wagon track slag entrapment will occur.

The hot pass should be started as soon as possible after completely finishing the root pass, **always within five minutes.**

The typical current for a hot pass ranges from 160 to 200 amps with either 5/32" (4.0mm) or 3/16" (5.0mm) electrodes. The welding travel speed increases with increasing current, as does the ability to clean out wagon tracks. The risk of burning through, especially on the top and the bottom of the pipe also increases and the usable length of electrode decreases. With high current, the electrode may overheat and catch fire. At this point, even if a long stub remains, welding should stop and the electrode should be thrown away.

With low current, there is little risk of burning through, but welding progresses slower and more care must be taken to assure that the wagon tracks are eliminated.

For the passes after the root pass, the tap setting is generally not adjusted. The current should be adjusted by adjusting the fine control. Typically this is done with a remote control.

With the SAE-400, the left tap (Job Selector) should be increased to run the hot pass. Using the Commander 300, the hot pass might be run with the 230 max tap and the control increased to 7 or 8.

Fill passes are usually run with 3/16" (4.8mm) or 5.0mm electrodes. Depending on the wall thickness, interpass temperature, etc., the current could be between 160 and 200 amps, which may not require changing the machine setting from the hot pass.

A slight side-to-side weave should be used when welding a fill pass. This allows the bead to wet-in properly with the side walls and helps fill the groove.

The current used on stripper passes depends on which diameter of electrode is to be used. The purpose of a stripper pass is to fill the joint up to flush. Instead of high travel speeds, lower currents may be used.

Before welding the cap pass, the concave portions of the weld should be welded up to flush with stripper passes, commonly required only in the 2 to 5 o'clock positions. Either 5/32" (4.0 mm) or 3/16" (5.0 mm) diameter electrodes can be used.

Cap passes are frequently run with lower currents than the fill passes. With 150 amps and a 3/16" (5.0mm) diameter electrode, it is possible to put in a uniform bead all the way around the pipe.

Preventing Cracking

Good welding practice is essential in preventing weld cracking, which includes preheating when needed. The welding techniques described in this book will minimize the defects which could cause cracking. Depositing the hot pass in a timely manner is helpful, as well as depositing as large a root pass as possible.

The need for preheating varies considerably depending on the grade of pipe steel. The tendency to crack increases with increasing pipe strength, wall thickness, carbon and alloy content, as well as decreasing ambient temperature. Welding low strength pipe in warm weather, the need to preheat may not be required, (although recommended for moisture removal). Thick wall, high strength pipe being welded in cold weather may require up to 350°F (177°C) preheat. Specific preheat requirements must be determined for each situation.

Techniques for Welding High Strength Pipe (X-60, X-65, X-70 and X-80 Pipe)

These recommendations are suggested to help produce crack-free welds with a minimum of defects on high strength pipe.

- Joint preparation and line-up must be carefully controlled. **High-low conditions should be held to a minimum.**
- Thin walled [up to 3/8" (10mm)] X-80 pipe can be welded with Shield-Arc® 90. Weld X-70 pipe with either Shield-Arc 80 or Shield-Arc 70+. Pipes X-60 and X-65 pipes can be welded with Fleetweld 5P+, Shield-Arc HYP, Shield-Arc HYP+, Shield-Arc 70+ or Shield-Arc 80.
- Preheat cold pipe to at least 70°F (21°C). The exact degree of preheat depends on the pipe steel, but preheating up to 350°F (177°C) would not be unreasonable for X-80 pipe.

- An internal fit-up clamp should not be removed until the entire root pass is complete.
- Fewer defects will be seen if restarts and stops (craters) are ground out, with the stops ground down to a feathered edge.
- Don't start the root pass welds at exactly the top of the pipe (12 o'clock position) or end them at exactly the bottom (6 o'clock position). Stopping the weld at the 6 o'clock position can contribute to burnthrough, tie-in or suck-back problems.
- When finishing an electrode on the root pass, a fast pullout (flicking the electrode) can reduce the size of the remaining keyhole, making tie-in easier.
- Since reverse polarity (DC+) is commonly used by U.S. pipeline operators for root pass welding, switch to straight polarity (DC-) when burn through, internal undercut and hollow bead defects persist. Polarity change is an essential variable in API 1104 code - requiring a procedure qualification.
- Excessive travel speed in either the root or hot pass will cause defects.
- Start and complete the hot pass immediately after completion of the root pass.
- If the temperature of the pipe has dropped below the prescribed interpass temperature, reheat the entire joint.

Vertical Down Procedures

(E6010, E7010, E8010 or E9010)

DC+

Currents up to 200 amps are often used on the hot and fill passes

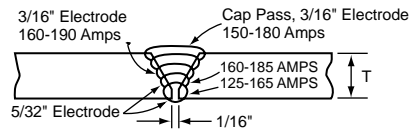

but cause premature coating breakdown and large stub losses.

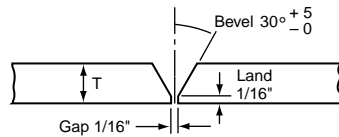

Use 1/8" (3.2 mm) diameter electrode for the stringer bead when the gap is too small to permit use of the 5/32" (4.0 mm) size or where the silicon level causes a larger than normal keyhole.

Stripper passes may be required in the 2 to 5 o'clock position.

| Pipe Wall Thickness | | No. of Passes |
|---------------------|--------|---------------|
| Inches | (mm) | |
| 5/16 | (7.9) | 4 |
| 3/8 | (9.5) | 5 |
| 1/2 | (12.7) | 7 |

The number of passes may vary depending on the operator, electrode diameter and procedure.

**Alternate Vertical Down Stringer Bead Procedure
(E6010, E7010, E8010 or E9010)**

DC-

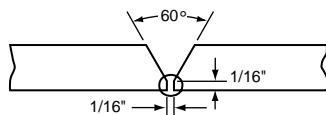

- (1) Root pass welding with 3/16" (4.8mm) diameter electrode requires more operator skill. Pipe land and gap tolerances are more critical when using 3/16" (4.8mm) electrode for stringer bead applications. Lower consumable cost is the primary advantage for 3/16" (4.8mm) diameter. Its use will not provide any significant increase in arc speed over 5/32"(4.0mm) diameter.

Cross Country Pipe
Vertical Down Electrode Consumption

| Wall Thickness | | | | | | |
|--|-------|-------|-------|-------|-------|-------|
| 5/16" | | | | 3/8" | | |
| Electrode Required per Joint (lbs.) ⁽¹⁾ | | | | | | |
| Pipe Diameter | 5/32" | 3/16" | Total | 5/32" | 3/16" | Total |
| 6 Inch | .34 | .54 | .88 | .34 | .86 | 1.2 |
| 8 Inch | .45 | .71 | 1.2 | .45 | 1.1 | 1.6 |
| 10 Inch | .56 | .88 | 1.4 | .56 | 1.4 | 2.0 |
| 12 Inch | .67 | 1.0 | 1.7 | .67 | 1.7 | 2.4 |
| 14 Inch | .73 | 1.1 | 1.8 | .73 | 1.8 | 2.5 |
| 16 Inch | .84 | 1.3 | 2.1 | .84 | 2.1 | 2.9 |
| 18 Inch | .94 | 1.5 | 2.4 | .94 | 2.3 | 3.2 |
| 20 Inch | 1.1 | 1.6 | 2.6 | 1.1 | 2.6 | 3.7 |
| 22 Inch | 1.2 | 1.8 | 3.0 | 1.2 | 2.9 | 4.1 |
| 24 Inch | 1.3 | 2.0 | 3.3 | 1.3 | 3.1 | 4.4 |
| 26 Inch | 1.4 | 2.1 | 3.5 | 1.4 | 3.4 | 4.8 |
| 28 Inch | 1.5 | 2.3 | 3.8 | 1.5 | 3.7 | 5.2 |
| 30 Inch | 1.6 | 2.5 | 4.1 | 1.6 | 3.9 | 5.5 |
| 32 Inch | 1.7 | 2.6 | 4.3 | 1.7 | 4.2 | 5.9 |
| 34 Inch | 1.8 | 2.8 | 4.6 | 1.8 | 4.4 | 6.2 |
| 36 Inch | 1.9 | 2.9 | 4.8 | 1.9 | 4.7 | 6.6 |
| 38 Inch | 2.0 | 3.1 | 5.1 | 2.0 | 5.0 | 7.0 |
| 40 Inch | 2.1 | 3.3 | 5.4 | 2.1 | 5.2 | 7.3 |
| 42 Inch | — | — | — | 2.2 | 5.5 | 7.7 |
| 44 Inch | — | — | — | 2.3 | 5.7 | 8.0 |
| 46 Inch | — | — | — | 2.4 | 6.0 | 8.4 |
| 48 Inch | — | — | — | 2.5 | 6.3 | 8.8 |

⁽¹⁾ Includes four inch stub lengths. These figures will vary with different stub loss practices.

Quantities required for the 5/32" diameter will vary based on travel speeds of the root pass and hot pass. Slow travel speeds may increase these quantities by up to 50%.

| Wall Thickness | | | | | | | | |
|---|-------|-------|-------|-------|-------|-------|-------|-------|
| 1/2" | | | 5/8" | | | 3/4" | | |
| Electrode Required per Joint (lbs.) (1) | | | | | | | | |
| 5/32" | 3/16" | Total | 5/32" | 3/16" | Total | 5/32" | 3/16" | Total |
| .45 | 2.2 | 2.7 | — | — | — | — | — | — |
| .56 | 2.7 | 3.3 | — | — | — | — | — | — |
| .67 | 3.2 | 3.9 | — | — | — | — | — | — |
| .73 | 3.5 | 4.2 | .73 | 5.7 | 6.4 | .73 | 8.3 | 9.0 |
| .84 | 4.0 | 4.8 | .84 | 6.5 | 7.3 | .84 | 9.4 | 10.2 |
| .94 | 4.5 | 5.4 | .94 | 7.3 | 8.2 | .94 | 10.6 | 11.5 |
| 1.1 | 5.0 | 6.1 | 1.1 | 8.1 | 9.2 | 1.1 | 11.8 | 12.9 |
| 1.2 | 5.5 | 6.7 | 1.2 | 8.9 | 10.1 | 1.2 | 13.0 | 14.2 |
| 1.3 | 6.0 | 7.3 | 1.3 | 9.7 | 11.0 | 1.3 | 14.2 | 15.5 |
| 1.4 | 6.5 | 7.9 | 1.4 | 10.5 | 11.9 | 1.4 | 15.3 | 16.7 |
| 1.5 | 7.0 | 8.5 | 1.5 | 11.3 | 12.8 | 1.5 | 16.5 | 18.0 |
| 1.6 | 7.5 | 9.1 | 1.6 | 12.1 | 13.6 | 1.6 | 17.7 | 19.3 |
| 1.7 | 8.0 | 9.7 | 1.7 | 13.0 | 14.7 | 1.7 | 18.9 | 20.6 |
| 1.8 | 8.6 | 10.3 | 1.8 | 13.8 | 15.6 | 1.8 | 20.1 | 21.9 |
| 1.9 | 9.1 | 11.0 | 1.9 | 14.6 | 16.5 | 1.9 | 21.3 | 23.2 |
| 2.0 | 9.6 | 11.6 | 2.0 | 15.4 | 17.4 | 2.0 | 22.4 | 24.4 |
| 2.1 | 10.1 | 12.2 | 2.1 | 16.2 | 18.3 | 2.1 | 23.6 | 25.7 |
| 2.2 | 10.6 | 12.8 | 2.2 | 17.0 | 19.2 | 2.2 | 24.8 | 27.0 |
| 2.3 | 11.1 | 13.4 | 2.3 | 17.8 | 20.1 | 2.3 | 26.0 | 28.3 |
| 2.4 | 11.6 | 14.0 | 2.4 | 18.6 | 21.0 | 2.4 | 27.2 | 29.6 |
| 2.5 | 12.1 | 14.6 | 2.5 | 19.4 | 21.9 | 2.5 | 28.3 | 30.8 |

Thin Wall Pipe Procedures

Vertical Down

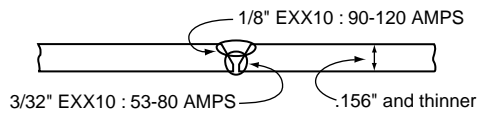

Polarity DC+

Fleetweld 5P+ is recommended. However, Fleetweld 5P, Shield-Arc 85 or Shield-Arc HYP+ can be used, providing the same diameter electrode is used.

Vertical Down Electrode Consumption

| Wall Thickness | | | |
|--|-------|------|-------|
| .125" | | | |
| Electrode Required per Joint (lbs.) ⁽¹⁾ | | | |
| Pipe Diameter | 3/32" | 1/8" | Total |
| 4 Inch | .071 | .092 | .163 |
| 4-1/2 Inch | .080 | .102 | .182 |
| 6 Inch | .106 | .138 | .244 |
| 6-5/8 Inch | .118 | .152 | .270 |
| 8 Inch | .142 | .184 | .326 |
| 8-5/8 Inch | .153 | .198 | .351 |
| 10 Inch | .178 | .230 | .408 |
| 10-3/4 Inch | .191 | .247 | .438 |
| 12-3/4 Inch | .223 | .289 | .512 |
| 14 Inch | .248 | .323 | .571 |
| 16 Inch | .284 | .369 | .653 |
| 20 Inch | .355 | .461 | .816 |
| 24 Inch | — | — | — |
| 28 Inch | — | — | — |
| 32 Inch | — | — | — |
| 36 Inch | — | — | — |

⁽¹⁾ Includes four inch stub lengths. These figures will vary with different stub loss practices.

Butt Weld

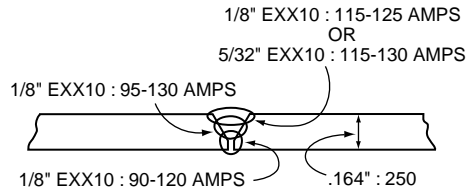

Polarity DC+

In some cases 5/32" (4.0 mm) diameter electrode may be used for the recommended. For root pass welding, see Alternate Vertical Down Procedure on page 16.

| Wall Thickness | | | | | |
|---|-------|-------|-------|-------|-------|
| .188" | | | .250" | | |
| Electrode Required per Joint (lbs.) (1) | | | | | |
| 1/8" | 5/32" | Total | 1/8" | 5/32" | Total |
| .196 | .146 | .342 | .232 | .177 | .409 |
| .221 | .164 | .385 | .261 | .199 | .460 |
| .294 | .219 | .513 | .348 | .268 | .616 |
| .325 | .242 | .567 | .384 | .293 | .677 |
| .392 | .292 | .684 | .464 | .354 | .818 |
| .422 | .314 | .736 | .500 | .382 | .882 |
| .490 | .365 | .855 | .581 | .442 | 1.023 |
| .526 | .392 | .918 | .623 | .475 | 1.098 |
| .615 | .458 | 1.073 | .727 | .552 | 1.279 |
| .686 | .520 | 1.206 | .812 | .615 | 1.427 |
| .784 | .593 | 1.377 | .929 | .703 | 1.632 |
| .980 | .741 | 1.721 | 1.161 | .879 | 2.040 |
| 1.177 | .890 | 2.067 | 1.393 | 1.062 | 2.455 |
| 1.372 | 1.040 | 2.412 | 1.624 | 1.230 | 2.854 |
| 1.568 | 1.186 | 2.754 | 1.858 | 1.406 | 3.264 |
| 1.764 | 1.338 | 3.102 | 2.089 | 1.582 | 3.671 |

Quantities required for the smaller diameter electrode may vary by up to 50%, based on size and travel speed of the root pass. Heavier cap passes will increase total electrode requirements by up to 50%.

Vertical Down - Bell & Spigot

Use a straight progression or short whipping technique. The latter is better for poor fit up and also for controlling the puddle in the 5 to 7 o'clock position. Use one pass. If portions of the weld are shallow, apply a second pass.

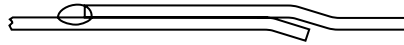

Electrode Consumption

| Wall Thickness | | | Electrode Required per Joint (lbs) ⁽¹⁾ | | | |
|----------------|---------|----------|--|--------|------|--------|
| | | | Pipe Diameter | | | |
| Gauge | Decimal | Fraction | 4" | 4-1/2" | 6" | 6-3/8" |
| 14 | .075" | 5/64" | .041 | .046 | .062 | .068 |
| 13 | .090" | 3/32" | .053 | .059 | .078 | .088 |
| 12 | .105" | 7/64" | .078 | .088 | .114 | .129 |
| — | .125" | 1/8" | .095 | .107 | .142 | .157 |
| 10 | .135" | 9/64" | .100 | .113 | .150 | .166 |

| Wall Thickness | Pass No. | Electrode & Diameter (Inches) | Current Range (DC+) |
|----------------|----------|-------------------------------|---------------------|
| .075" | 1 | 1/8 Fleetweld 5P+ | 80-100 |
| .090" | 1 | 1/8 Fleetweld 5P+ | 80-100 |
| .105" | 1 | 5/32 Fleetweld 5P+ | 120-130 |
| .125" | 1 | 5/32 Fleetweld 5P+ | 120-130 |
| .135" | 1 | 5/32 Fleetweld 5P+ | 130-140 |

<http://www.rapidwelding.com>

Double Ending

Double ending is the automatic submerged arc welding of two lengths of pipe into one longer length. It is practical where terrain permits hauling the automatic welding stations and the double lengths of pipe.

The automatic welding methods weld joints faster than is possible with stick electrodes. This reduces welding costs, but, more importantly, it increases the miles of pipe that can be laid each day.

Double ending also increases pipe laying speed because the submerged arc process consistently makes high strength welds of excellent X-ray quality. Few "cutouts" are required.

Along the Right of Way

Double ending along the right of way utilizes portable automatic welding stations which are moved frequently as the line progresses. It eliminates the need for hauling double lengths of pipe long distances.

Weld the root pass with stick electrode or semi-automatic processes and the usual internal line-up clamps. To avoid cracking, the stringer bead should have a minimum of 3/16" (4.8 mm) throat and, ideally, the first automatic bead should be started immediately after completion of the stringer bead. The other beads are welded by rotating the pipe beneath an automatic welding head.

Stationary Double Ending

The stationary double ending automatic welders work at pipe delivery points. The double length pipe section are hauled to the pipeline for laying. When appropriate, the automatic welders are moved to the next pipe delivery station.

Both two and three station equipment is used. With three station equipment, only the first pass is welded at the first station. The other external beads are welded at the second station. With two station equipment, all external beads are welded at the first station. The internal bead is always welded at the final station.

NOTE: The Lincoln Electric Company strongly recommends for weldments intended for sour gas, sour crude, or other critical service applications that the customer verifies that both the level of hardness and variation in hardness of the weld, heat affected zone, and base plate are within acceptable limits.

Flux and Electrode Selection

Because of the high dilution characteristic of this type of welding, the mechanical properties of the weld are highly dependent on the chemistry of the pipe. All welding materials and procedures should be tested on actual pipe steel under field conditions to determine usability.

Flux

860 neutral flux is the most recommended flux, depending on job requirements and welding conditions. 882 neutral flux may be used on some lower carbon pipe heavier wall thicknesses.

Electrodes

L-60 - Most popular choice with 860 flux. Lowest hardness. Preferred for pipe intended to carry sour gas or sour crude.

L-61 - Intermediate hardness. Improved bead appearance over L-60.

L-50 - Highest hardness of mild steel electrodes. Improved bead appearance over L-61. Improved impact strength vs. L-60 at -20°F (-29°C) on pipe 3/4" (19 mm) wall thickness or greater.

LA-75 - Similar in hardness to L-50. Best bead appearance. Highest impact strength at -50°F (-45°C) on wall thicknesses of approximately 3/4" (19mm) or greater. Deposits contain approximately 1% nickel.

860/L-60 will meet the minimum yield requirements and produce low hardness and good impact strength at -20°F (-29°C) on X-42 through X-60 pipe. 860/L-60 will also meet the minimum yield requirements and produce low hardness and good impact strength on most X-65 and some X-70 pipe, depending on plate chemistry, wall thickness, and procedures.

If strength is too low with L-60, it may be necessary to use L-61 or L-50. On some pipe steels, L-61 or L-50 with 860 flux may be required to meet minimum Charpy impact requirements. The weld matrix hardness and tensile strength will be higher with L-61 or L-50 than with L-60. With single arc double ending procedures, L-70 will not produce higher impact strength than L-60 and will result in higher weld matrix hardness.

Because of the large variations possible in pipe chemistry, all consumables should be tested on actual pipe steel to verify that requirements will be met.

API Pipe Steel

The following data is partial review of the 38th edition (May 1990) of API specification 5L. For the latest specific details, obtain a copy of API Standard 5L .

Definitions

The most common steel used for oil and gas cross country pipeline is the API 5LX series. Meanings of these pipe designation are as follows:

- 5L Specification for line pipe.
- X Grade designation for high strength line pipe.

The two numbers following the "X" are the first two digits of the minimum yield strength. For example X-60 has a minimum yield strength of 60,000 psi (414 MPa).

Carbon and Manganese Content

When the pipe carbon and manganese content is near the maximum allowed by the specifications, welding without cracking is difficult, particularly in cold weather. Therefore, pipe is commonly made using steel of lower carbon and manganese content. High mechanical properties are obtained by cold expanding the pipe.

When pipe analysis is near maximum, follow the techniques under "Preventing Cracking" on page 10.

Chemical Requirements for Heat Analysis
Process of Manufacture: Electric furnace, open-hearth,
basic-oxygen or killed deoxidized basic-bessemer

| Welded | Grade | Carbon Max. (%) | Manganese Max. (%) | Phosphorus Max. (%) | Sulfur Max. (%) |
|---------------|---|--------------------|-----------------------|------------------------|--------------------|
| Non-expanded | X-42 | 0.28 | 1.25 | 0.04 | 0.05 |
| Non-expanded | X-46, X-52 | 0.30 | 1.35 | 0.04 | 0.05 |
| Cold-expanded | X-42, X-46, X-52 | 0.28 | 1.25 | 0.04 | 0.05 |
| Non-expanded | X-56 ⁽¹⁾ , X-60 ⁽¹⁾ | 0.26 | 1.35 | 0.04 | 0.05 |
| (or) | X-65 ⁽¹⁾ | 0.26 | 1.40 | 0.04 | 0.05 |
| | X-70 ⁽¹⁾ | 0.23 | 1.60 | 0.04 | 0.05 |
| Cold-expanded | X-80 | 0.18 | 1.80 | 0.03 | 0.018 |

⁽¹⁾ May also contain small amounts of columbium, vanadium or titanium.

High Silicon Pipe

Surface pinhole porosity may sometimes be encountered when welding 5LX pipe containing high silicon (up to 0.35%). Use currents in the lower end of the current range or smaller diameter electrodes to minimize this problem.

X-56, X-60, X-65, X-70 & X-80 Pipe

Since these pipe steels may have an analysis other than specified see footnote ⁽¹⁾, above, and there is no upper limit on strength, pipe with a tensile strength of 100,000 psi (689 MPa), sometimes arrives on the job. Making crack-free welds in this steel requires careful attention to the "Techniques for Welding High Strength Pipe" discussed on page 10.

Preheat and interpass temperature control are recommended for optimum mechanical properties, crack resistance and hardness control. This is particularly important on multiple pass welds and heavier plate. Job conditions, prevailing codes, high restraint, alloy level and other considerations may also require preheat and interpass temperature control.

NOTE: The Lincoln Electric Company strongly recommends for weldments intended for sour gas, sour crude, or other critical service applications that the customer verifies that both the level of hardness and variation in hardness of the weld, heat affected zone, and base plate are within acceptable limits.

Pipe Grades - Minimum Yield and Tensile Strengths

| Pipe Grade | Minimum Yield | | Minimum Tensile | |
|------------|---------------|-----|-----------------------|-----|
| | psi | MPa | psi | MPa |
| X-42 | 42,000 | 290 | 60,000 | 414 |
| X-46 | 46,000 | 317 | 63,000 | 434 |
| X-52 | 52,000 | 358 | 66,000 | 455 |
| X-56 | 56,000 | 386 | 71,000 | 489 |
| X-60 | 60,000 | 414 | 75,000 | 517 |
| X-65 | 65,000 | 448 | 77,000 | 531 |
| X-70 | 70,000 | 483 | 82,000 | 565 |
| X-80 | 80,000 | 552 | 90,000 ⁽²⁾ | 620 |

⁽²⁾ 120,000 maximum.

Consumables for Pipe Welding

Currently, there are **four** categories of consumables available for welding pipes of various strength levels.

- **SMAW (Shielded Metal Arc Welding)**

- Cellulosic Electrodes
- Vertical Up, Low Hydrogen Electrodes
- Vertical Down, Low Hydrogen Electrodes

- **FCAW (Flux-Cored Arc Welding)**

- Self-Shielded (Innershield[®]) Electrodes
- Gas-Shielded (Outershield[®]) Electrodes

- **GMAW (Gas Metal Arc Welding)**

- Solid Wire Electrodes
- Root Pass Welding with STT Power Supply

- **SAW (Submerged Arc Welding)**

- Solid Wire Electrodes with Flux for Double Ending⁽¹⁾

For any grade of pipe, there are possibilities for both process and the consumable to be used. The table below gives various electrode choices for different strength pipes. These are for fill and cap passes. Lower strength electrodes commonly are used for root and hot passes.

| Electrode | X-52 & Under | X-56 | X-60 | X-65 | X-70 | X-80 |
|------------------|--------------|------|------|------|------|------|
| Fleetweld 5P | ✓ | ✓ | | | | |
| Fleetweld 5P+ | ✓ | ✓ | ✓ | ✓ | | |
| Shield-Arc HYP | ✓ | ✓ | ✓ | ✓ | | |
| Shield-Arc HYP+ | ✓ | ✓ | ✓ | ✓ | | |
| Shield-Arc 85 | ✓ | ✓ | ✓ | ✓ | | |
| Shield-Arc 70+ | | ✓ | ✓ | ✓ | ✓ | |
| Shield-Arc 80 | | ✓ | ✓ | ✓ | ✓ | |
| Shield-Arc 90 | | | | ✓ | ✓ | ✓ |
| Lincoln 16P | ✓ | ✓ | ✓ | ✓ | | |
| Lincoln 18P | | ✓ | ✓ | ✓ | ✓ | ✓ |
| Lincoln LH D-80 | | ✓ | ✓ | ✓ | ✓ | |
| Lincoln LH D-90 | | ✓ | ✓ | ✓ | ✓ | ✓ |
| Lincoln LH D-100 | | ✓ | ✓ | ✓ | ✓ | ✓ |
| NR-207, 207-H | ✓ | ✓ | ✓ | ✓ | ✓ | |
| NR-208-H | | ✓ | ✓ | ✓ | ✓ | ✓ |
| SuperArc L-50 | ✓ | ✓ | ✓ | ✓ | | |
| SuperArc L-56 | ✓ | ✓ | ✓ | ✓ | | |
| SuperArc LA-75 | | | ✓ | ✓ | ✓ | |
| SuperArc LA-90 | | | ✓ | ✓ | ✓ | ✓ |
| SuperArc LA-100 | | | ✓ | ✓ | ✓ | ✓ |

Consumables for High Strength Pipe

The mechanical requirements of x-80 pipe are a yield strength of at least 80,000 psi (551 MPa), minimum ultimate tensile strength of 90,000 psi (620 MPa), and a maximum ultimate tensile strength of 120,000 psi (827 MPa).

The mechanical property requirements of the weld are not as clearly defined. API 1104 requires that when tested, with a transverse tensile test, either:

- (1) the weld metal exceeds the specified minimum tensile strength of the pipe (with the root pass and cap pass reinforcement in tact),
or
- (2) the pipe material breaks first. Because the reinforcement is left intact, the weld metal does not necessarily need to be as strong as the pipe.

A level of ductility in the weld metal is required to pass a guided bend test, but there are no explicit requirements for the tensile test.

Strength Requirements for Pipe Grades

| Pipe Grade | Minimum Yield Strength | | Minimum Tensile Strength | | Maximum Ultimate Tensile Strength | |
|------------|------------------------|-----|--------------------------|-----|-----------------------------------|-----|
| | psi | MPa | psi | MPa | psi | MPa |
| X-42 | 42,000 | 289 | 60,000 | 413 | — | — |
| X-46 | 46,000 | 317 | 63,000 | 434 | — | — |
| X-52 | 52,000 | 358 | 66,000 | 455 | — | — |
| X-56 | 56,000 | 386 | 71,000 | 489 | — | — |
| X-60 | 60,000 | 413 | 75,000 | 517 | — | — |
| X-65 | 65,000 | 448 | 77,000 | 530 | — | — |
| X-70 | 70,000 | 482 | 82,000 | 565 | — | — |
| X-80 | 80,000 | 551 | 90,000 | 620 | 120,000 | 827 |

Lincoln Products for X-80 Pipe

The following is a list, by process, of Lincoln electrodes which will meet the strength requirements for X-80 pipe.

SMAW

For a conventional, vertical up basic low hydrogen root pass, we recommend **Lincoln 16P**. Our European subsidiaries also have Conarc® 49 C and Kryo® 1 for root pass welding. None of these meet the strength requirements for an X-80 pipe. Depending on the procedure, undermatched root pass electrodes are used to take advantage of the (generally) higher ductility. Overmatching electrodes are then used for the fill and cap passes.

Lincoln 16P

| | |
|----------------------------|-------------------------|
| Yield Strength | 71,200 psi (491 MPa) |
| Tensile Strength | 90,900 psi (627 MPa) |
| Elongation | 22% |
| Hardness (R _b) | 88 |
| CVN at -20°F (-29°C) | 48 ft. lbs. (65 Joules) |
| CVN at -50°F (-45°C) | 36 ft. lbs. (49 Joules) |

Fill and cap passes can be welded vertical up with **Lincoln 18P** to meet the strength requirements. Jet-LH 8018-C3 MR generally meets the specified criteria, however, the nickel content is approximately 1%, and can exceed the limit often imposed for sour service.

Lincoln 18P

| | |
|----------------------|--------------------------|
| Yield Strength | 88,700 psi (611 MPa) |
| Tensile Strength | 99,000 psi (682 MPa) |
| Elongation | 28% |
| CVN at -20°F (-29°C) | 83 ft. lbs. (112 Joules) |
| CVN at -50°F (-45°C) | 57 ft. lbs. (77 Joules) |

Vertical down welding of X-80 pipe can be done with Lincoln **LH-D90**, which meets E9018-G electrode classification. Some data taken from a vertical down weld made on flattened X-80 pipe:

Lincoln LH-D90

| | |
|----------------------|-------------------------|
| Yield Strength | 87,800 psi (605 MPa) |
| Tensile Strength | 97,000 psi (669 MPa) |
| Elongation | 26% |
| CVN at -50°F (-45°C) | 62 ft. lbs. (84 Joules) |

Lincoln LH-D100

| | |
|----------------------|-------------------------|
| Yield Strength | 87,000 psi (600 MPa) |
| Tensile Strength | 98,500 psi (679 MPa) |
| Elongation | 24% |
| CVN at -50°F (-45°C) | 62 ft. lbs. (84 Joules) |

Vertical Down Procedures for LHD type Electrodes

- To avoid starting porosity, the electrode angle should be maintained perpendicular to the pipe when striking the arc.
- The electrode should be tapped against the pipe at the back end (top) of the crater and held close to the pipe.
- As the hot start/pencil point melts away, maintain the electrode in the same location with a very short arc. When the arc is stabilized, advance the electrode.
- A short arc (1/8") should be maintained, instead of dragging the electrode. When the electrode is dragged, a convex bead will result, especially on the bottom half of the pipe. With a short arc, the bead will be flatter.

This electrode is not recommended for root pass welding. The electrode does not penetrate sufficiently to accommodate even a small degree of mismatch (high/low condition).

When a 60° included angle joint preparation is used, the normal welding sequence would include two passes with a 1/8" (3.2 mm) electrode. After that, one or two full weave layers would be made with the 5/32" (4.0 mm) electrode. A split weave procedure would normally be used after that.

Approximate currents for this electrode are 140 amps for the 1/8" (3.2 mm) electrode, 170 amps for the 5/32" (4.0 mm) electrode, and 190 amps for the 3/16" (4.8 mm) electrode. Independent of what the recommended current setting might be, the electrode works best when run at the highest current possible without overheating. When the optimum current is used, the electrode will glow orange immediately after stopping the arc, but not overheat or breakdown when a 3 inch stub remains.

A drag angle is normally used while welding vertically down. This angle can be 30° at the 3 o'clock position, although the exact electrode angle will depend on the current used and the ability of the pipe to cool the weld pool.

On the bottom of a pipe, the electrode angle should tend towards perpendicular to the pipe, and after the 5 o'clock position, a slight push angle can be used. With a push angle on the bottom, the

tendency for convex bead shapes can be overcome. With a 10° push angle and a small “horseshoe” weave, it is possible to maintain a flat bead profile.

A limited amount of weaving can be used with LHD type electrodes. As long as the preheat, interpass, and wall thickness conditions allow it, a weave of up to one electrode diameter can reasonably be used. Weaving wider than one electrode diameter can lead to slag entrapment.

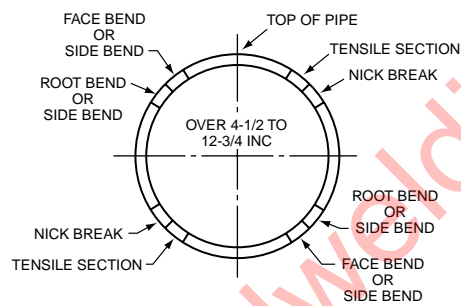

Lincoln Electric has a cellulosic electrode which meets the strength level requirements of X-80 pipe. Although cellulosic electrodes are not generally considered for this strength level, thin wall pipes have been welded successfully with these products. Root and hot passes on high strength pipe have been made with this electrode without problems. **Shield-Arc 90** has an E9010-G classification, which carries with it the requirement of a 78,000 psi (538 MPa) minimum yield strength and a 90,000 psi (620 MPa) minimum tensile strength. Typical AWS test results for Shield-Arc 90 lists the following data for the 3/16" (5.0 mm) diameter.

Shield-Arc 90

| | |
|----------------------|-------------------------|
| Yield Strength | 84,200 psi (580 MPa) |
| Tensile Strength | 94,400 psi (651 MPa) |
| Elongation | 26% |
| CVN at -20°F (-29°C) | 72 ft. lbs. (97 Joules) |
| CVN at -50°F (-45°C) | 46 ft. lbs. (62 Joules) |

FCAW (Self-Shielded)

Innershield NR-208-H was redesigned recently to meet the strength requirements of X-80 pipe. The typical results gave the following properties.

NR-208-H

| | |
|----------------------|-------------------------|
| Yield Strength | 81,070 psi (559 MPa) |
| Tensile Strength | 94,100 psi (650 MPa) |
| Elongation | 27% |
| CVN at -20°F (-29°C) | 53 ft. lbs. (72 Joules) |
| CVN at -50°F (-45°C) | 52 ft. lbs. (70 Joules) |

NR-208-H typically has a nickel content of approximately 0.85%. The yield strength of NR-208-H can reach as high as 87,000 psi (600 MPa), and the tensile strength can reach as high as 100,000 psi (684 MPa).

FCAW - Gas-Shielded

A gas-shielded, flux-cored electrode, which could conceivably be used to weld an X-80 pipe would be **Outershield 91K2-H**. Typical properties from an AWS plate.

Outershield 91K2-H

| | |
|----------------------|-------------------------|
| Yield Strength | 88,400 psi (609 MPa) |
| Tensile Strength | 95,500 psi (658 MPa) |
| Elongation | 27% |
| CVN at -60°F (-51°C) | 60 ft. lbs. (81 Joules) |

Gas mixture of 75% Argon/25% CO₂ was used.

GMAW

There are two possibilities in the Lincoln Electric product line of meeting the strength level requirements with GMAW electrode. **LA-100** is an ER100S-G electrode, whose typical properties on an AWS plate using 98% Argon/2% Oxygen shielding gas are as follows.

| LA-90 | |
|-------------------------|---------------------------|
| Yield Strength | 83,000 psi (572 MPa) |
| Tensile Strength | 95,000 psi (655 MPa) |
| Elongation | 27% |
| Hardness R _b | 93 |
| CVN at -60°F (-51°C) | 102 ft. lbs. (138 Joules) |

The manganese content of the deposited metal is over 1%, and the nickel is in the range of 1.9%.

Another possibility to meet the strength requirement would be **LA-90**, an ER80S-D2 and ER90S-D2 electrode. Depending on the shielding gas used, the wire diameter, and the actual procedure, this electrode would meet the strength requirement. Typical properties for this product, taken from a test plate welded with 1/16" (1.6mm) diameter electrode with 95% Argon/5% Oxygen shielding gas, are as follows:

| LA-100 | |
|-------------------------|---------------------------|
| Yield Strength | 108,000 psi (744 MPa) |
| Tensile Strength | 116,000 psi (800 MPa) |
| Elongation | 21% |
| Hardness R _b | 101 |
| CVN at -60°F (-51°C) | 110 ft. lbs. (149 Joules) |

For root pass welding, either of these electrodes could be welded with the Surface Tension Transfer™ (STT) power supply. Since this power supply is used only for the root pass, no mechanical property data is available. A CO₂ shielding gas is standard for this low spatter, low heat process.

Summary

Several alternatives are available for welding X-80 pipe, depending on the exact requirements for a project; hydrogen levels, compositional requirements (in particular, nickel), hardness, level of automation required, availability of machinery, degree of overmatch, and any number of other factors may determine the suitability of one product over another.

Pipe Welding Electrodes

Electrodes for Mild Steel Pipe

Fleetweld 5P (E6010)

Basic out-of-position electrode. Used for welding ASTM and X-42 through X-52 mild steel pipe. Your best choice for dirty, rusty, or painted pipe.

Fleetweld 5P+ (E6010)

Similar to Fleetweld 5P, with added advantages of quick striking, easy slag removal and improved final appearance. all position welding of pipe X-42 through X-52.

Shield-Arc 85 (E7010-A1)

Used for 1/2" Molybdenum pipe steels and X-42 through X-56 grade pipes. Can be handled vertical up or vertical down.

Shield-Arc HYP+ (E7010-P1)

Designed to provide improved welding characteristics for vertical down root, hot, fill or cap pass welding of API 5L pipe, grades X-52 through X-65 high strength pipe.

Shield-Arc HYP (E7010-G)

Specifically made for vertical down welding all passes on 5L or 5LX pipe, grades X-52 through X-65. Features easy operation, minimum wagon tracks and windows and almost no tendency for fill and cap pass pinholes.

Shield-Arc 70+ (E8010-G)

Very good electrode for root, hot, fill and cap passes. Primarily for vertical down, but can also be used for vertical up. Excellent wetting on the cap pass, steady concentrated arc.

Shield-Arc 80 (E8010-G)

Similar welding characteristics and bead appearance to Shield-Arc 70+ with much better low temperature impact properties. Excellent "stacking" ability, allowing slower travel speeds at high currents, thus allowing faster filling of joints.

Shield-Arc 90 (E8010-G)

Specifically designed for X-80 pipe. Similar to Shield-Arc 80 with higher strength. Can be used for root and hot passes, and for fill and cap passes up to 3/8" (9.5mm) pipe. With proper precautions, thicker wall pipe may also be welded without cracking.

Low Hydrogen Electrodes for Pipe Welding

Lincoln 16P (E7016)

Specially designed for vertical up welding of pipe. The thin coating of the 3/32" (2.4 mm) size allows for its use in root pass welding. Can

be used in grades X-52 through X-65. Because of its unique burn-off characteristics, it is recommended for welding of open joint gaps.

Lincoln 18P (E8018G)

Low hydrogen electrode designed primarily for vertical-up fill and cap pass welding of high strength pipelines, up to and including X-80 grade.

LH-D80, LH-D90 & LH-D100 (E8018-G, E9018-G & E10018-G)

These low hydrogen electrodes are designed for vertical down on high strength pipe up to and including X-80. They have significantly greater deposition rates than downhill cellulosic electrodes.

Jet-LH 8018-C3 MR (E8018-C3)

Produces a 1% nickel deposit for welding low temperature alloy pipe that require good notch toughness down to -60°F (51°C).

Jet-LH 8018-C1 MR (E8018-C1)

Capable of producing a 2-1/4% nickel deposit with notch toughness of 20 ft-lbs at -75°F (-59°C) for welding pipe for liquid ammonia, propane and other gases.

Jetweld LH-90 MR (E8018-B2)

Produces 1-1/4% chromium, 1/2% molybdenum deposit commonly required for high temperature, high pressure pipe.

Jetweld LH-100M1 MR (MIL-10018-M1)

Yield strength levels of 82-110,000 psi (565-758 MPa). Excellent notch toughness down to -60°F (-51°C).

Jetweld LH-110M MR (E11018-M)

Tensile strength levels of 110-128,000 psi (758-882 MPa).

Jet-LH 8018-B2 MR (E8018-B2)

Capable of producing a 1-1/4% chromium, 1% molybdenum deposit when design temperatures exceed 850°F (454°C).

Jet-LH 9018-B3 MR (E9018-B3)

Capable of producing a 2-1/4% chromium, 1% molybdenum deposit when design temperatures exceed 850°F (454°C).

Mechanical Properties
Welded and tested in accordance with appropriate
AWS or MIL specifications.

| Electrode | AWS Class | As-Welded | | | |
|-------------------------------|------------------|-------------------------------|-----------|-----------------------------|-----------|
| | | Tensile Strength psi (MPa) | | Yield Strength psi (MPa) | |
| Fleetweld 5P | E6010 | 60-76,000 (414-524) | | 48-65,000 (331-448) | |
| Fleetweld 5P+ | E6010 | 60-86,000 (414-593) | | 48-76,000 (331-524) | |
| Shield-Arc 85 | E7010-A1 | 70-78,000 (483-538) | | 57-71,000 (393-489) | |
| Shield-Arc HYP | E7010-G | 70-86,000 (483-593) | | 60-74,000 (414-512) | |
| Shield-Arc HYP+ | E7010-P1 | 77-86,000 (531-593) | | 63-71,400 (439-482) | |
| Shield-Arc 80 | E8010-G | 80-94,000 (552-648) | | 67-83,000 (462-572) | |
| Shield-Arc 70+ | E8010-G | 80-97,000 (552-669) | | 67-82,000 (462-565) | |
| Shield-Arc 90 | E9010-G | 90-100,000 (620-689) | | 77-88,000 (531-607) | |
| Low Hydrogen Electrode | | | | | |
| LH-D80 | E8018-G | 89,600 | (618) | 76,800 | (530) |
| Jet-LH 8018-C3 MR | E8018-C3 | 80-94,000 | (551-648) | 68-80,000 | (469-552) |
| Jet-LH 8081-C1 MR | E8018-C1 | 80-95,000 | (551-655) | 67-81,000 | (462-558) |
| LH-D80 | E8018-G | 89,000 | (618) | 76,800 | (530) |
| LH-D90 | E9018-G | 99,000 | (682) | 89,000 | (614) |
| LH-D100 | E10018-G | 106,000 | (731) | 98,500 | (679) |
| Jetweld LH-90 MR | E8018-B2 | 97-107,000 | (669-738) | 84-97,000 | (579-669) |
| Jetweld LH- 100M1 MR | MIL- 10018-M1 | 93-103,000 | (648-727) | 82-100,000 | (565-758) |
| Jet-LH 8018-B2 MR | E8018-B2 | 112-121,000 | (772-834) | 100-107,000 | (689-738) |
| Jetweld LH- 110M MR | E11018-M | 110-128,000 | (758-882) | 98-109,000 | (676-751) |
| Jet-LH 9018-B3 MR | E9018-B3 | 136-147,000 | | | |
| Lincoln 16P | E7016 | 85-90,100 | (586-621) | 74900-78,000 | (517-538) |
| Lincoln 18P | E8018-G | 99-105 | (683-727) | 88700-97200 | 612-650 |

⁽¹⁾ Stress relieved @ 1275°F (691°C).

⁽²⁾ Stress relieved @ 1125°F (607°C).

| % Elong. | Stress Relieved @ 1150°F (621°C) | | | | % Elong. |
|----------|----------------------------------|-----------|---------------------------|-----------|----------------------|
| | Tensile Strength | | Yield Strength | | |
| | psi | (MPa) | psi | (MPa) | |
| 22-33 | 60-69,000 | (414-476) | 48-61,000 | (331-421) | 28-36 |
| 22-33 | 67-78,000 | (461-538) | 51-67,000 | (351-461) | 30-34 |
| 22-30 | 70-84,000 | (483-579) | 57-74,000 | (393-512) | 22-30 |
| 22-30 | 80-82,000 | (552-565) | 72-76,000 | (496-524) | 24-27 |
| - | - | | - | | - |
| 19-26 | — | | — | | — |
| 19-31 | 80-88,000 | (552-607) | 65-78,000 | (448-538) | 29-31 |
| 17-26 | — | | — | | — |
| 28 | — | | — | | — |
| 24-30 | 75-84,000 | (517-579) | 66-73,000 | (455-503) | 24-32 |
| 19-25 | 80-96,000 | (552-662) | 66-81,000 | (455-558) | 19-32 |
| 28 | — | | — | | — |
| 29 | — | | — | | — |
| - | - | | - | | - |
| 17-24 | 90-107,000 | (620-738) | 77-95,000 ⁽¹⁾ | (531-655) | 17-24 |
| 20-24 | 99-111,000 ⁽²⁾ | (683-765) | 88-104,000 ⁽²⁾ | (607-717) | 20-26 ⁽²⁾ |
| 17-24 | 93-103,000 ⁽¹⁾ | (641-710) | 81-93,000 ⁽¹⁾ | (558-641) | 25-28 |
| 20-24 | 110-120,000 ⁽²⁾ | (758-827) | 95-107,000 ⁽²⁾ | (655-738) | 20-26 ⁽²⁾ |
| 15-22 | 100-114,000 ⁽¹⁾ | (689-786) | 86-100,000 ⁽¹⁾ | (593-689) | 21-25 |
| 28-30 | | | | | |
| 28 | | | | | |

NOTE: Mechanical properties obtained with each type electrode also depends upon (1) chemistry of the pipe, (2) welding procedures and (3) the rate of cooling. Since these factors vary between actual applications and testing conditions, the mechanical properties may also vary.

In-Plant Pipe

Vertical Up Welding

Pipe End Cleaning

Pipe may be covered with a variety of coatings, which include primers, epoxy, tar, paper, varnish, rust, scale, moisture or organic contaminants. Failure to recognize and properly clean these joints can contribute to rejected welds and costly repairs. Joint cleanliness is especially important in welding pipe.

Follow these guidelines to minimize welding defects such as root pass hollow bead:

- Moisture and condensation of any type must be removed prior to welding.
- Clean both ends of the pipe on the inside and outside surfaces. The area to be cleaned should extend at least 1" (25mm) from the end of the bevel on both the inside and outside surfaces.
- A recommended method for cleaning pipe is the use of a heavy duty straight shaft grinder with a rubber expanding wheel and a carbide coated sleeve. The small shaft and reduced overall weight allow easy access to both the inside and outside pipe surfaces.

Pipe End Preparation with No Backup Ring

The dimensional requirements for welding vertically up are shown below. A 1/8" (3.2mm) gap must be maintained accurately all the way around the joint. When no backup ring is used a 1/8" Fleetweld 5P or 5P+ are recommended for the root pass.

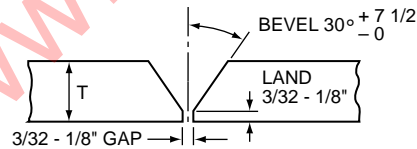

Pipe End Preparation With Backup Ring

Alloy pipe is often welded vertically up using a low hydrogen electrode. When a low hydrogen electrode is used for the first pass a backup ring may be used. With a backup ring, the pipe ends are made with a **feather edge**. The gap should be about the same as the diameter of the electrode with coating and must be consistent all the way around.

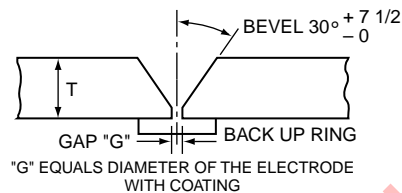

Mixed E6010, E7010, E8010, E9010 and Low Hydrogen Beads

When low hydrogen electrode is to be used, a root pass of EXX10 electrode may be necessary or advantageous. This usually arises when a special fitting with reduced gap is used or where a backup ring is undesirable.

The E6010 - E9010 root pass is needed to provide adequate penetration to reach the root of the joint. By applying the E6010 - E9010 stringer bead vertically down, the first weld can be applied at higher speeds. The smaller gap also reduces the amount of electrode needed to complete the weld.

Pipe Axis - Horizontal & Vertical

First Pass

The sections are lined and tacked into position with at least four tack welds. The root pass is made from bottom to top, one side at a time.

No Backup Ring

When no backup ring is used, the penetration must be complete on both lips and there must be some buildup on the inside of the joint. This inside bead should have an even surface and be at least 1/16" (1.6 mm) when starting a fresh electrode during the root pass, special care must be taken to maintain a smooth uninterrupted inside bead. With pipe axis vertical, some codes require a full width weave over the root pass (1/8" (3.2 mm) or greater).

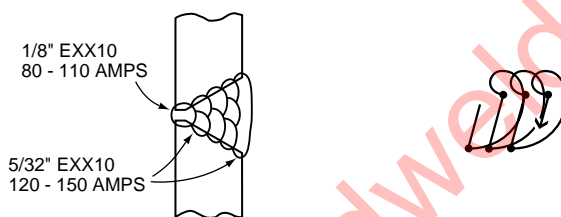

With Backup Ring

The root pass must penetrate into both the lands of both pipes and into the backup ring to weld both sections and the ring into one integral piece.

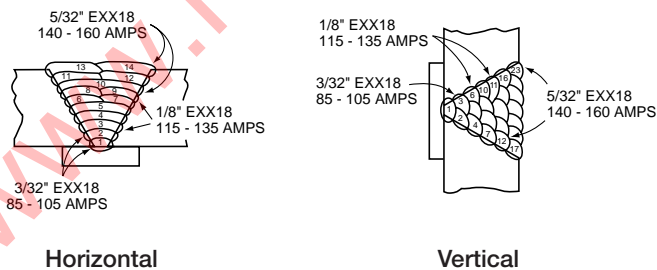

Filler Passes

Clean each bead before starting the next pass. Never start a bead at the same point as the previous bead was started. Use enough heat to assure complete fusion with the pipe wall and the adjacent bead.

The finish passes should be about walls and overlap the original gr

For horizontal cap passes, particular care should be exercised to

avoid undercutting on the top of the weld pass. Lower currents and a short arc should be used to minimize undercutting.

Vertical Up Procedures

Vertical Joint - (Pipe Axis Horizontal)

E6010, E7010, E8010 or E9010: DC+

Low Hydrogen Electrode: DC+

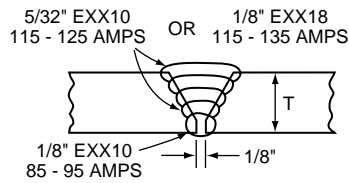

| Wall Thickness | | No. of Passes ⁽¹⁾ |
|----------------|--------|------------------------------|
| In. | (mm) | |
| 1/4 | (6.4) | 2 |
| 5/16 | (7.9) | 2 |
| 3/8 | (9.5) | 3 |
| 1/2 | (12.7) | 3 |
| 5/8 | (15.9) | 4 |
| 3/4 | (19.0) | 6 |
| 1 | (25.4) | 7 |

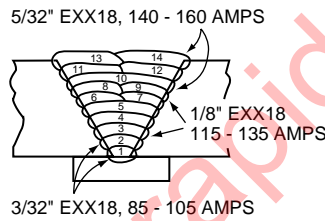

| Wall Thickness | | No. of Passes ⁽¹⁾ |
|----------------|--------|------------------------------|
| In. | (mm) | |
| 3/8 | (9.5) | 3 |
| 1/2 | (12.7) | 4 |
| 5/8 | (15.9) | 5 |
| 3/4 | (19.0) | 7 |
| 1 | (25.4) | 10 |

Horizontal Joint - (Pipe Axis Vertical)

E6010, E7010, E8010 or E9010: DC+

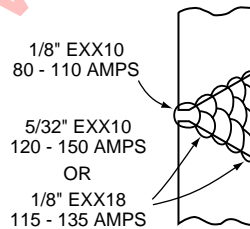

| Wall Thickness | | No. of Passes ⁽¹⁾ |
|----------------|--------|------------------------------|
| In. | (mm) | |
| 1/4 | (6.4) | 2 |
| 5/16 | (7.9) | 3 |
| 3/8 | (9.5) | 4 |
| 1/2 | (12.7) | — |
| 5/8 | (15.9) | — |
| 3/4 | (19.0) | — |
| 1 | (25.4) | — |

⁽¹⁾ The number of passes may vary depending on operator techniques.

| Wall Thickness | | | | | | |
|---|---------------|------|-------|----------------|------|-------|
| | 3/8" (9.5 mm) | | | 1/2" (12.7 mm) | | |
| Electrode Required per Joint (lbs) ⁽¹⁾ | | | | | | |
| Pipe Diameter In. (mm) | 3/32" | 1/8" | Total | 3/32" | 1/8" | Total |
| 6 In. (152.4 mm) | .51 | 1.34 | 1.85 | .51 | 2.31 | 2.82 |
| 8 In. (203.2 mm) | .70 | 1.8 | 2.5 | .70 | 3.1 | 3.8 |
| 12 In. (304.8 mm) | 1.0 | 2.7 | 3.7 | 1.0 | 4.7 | 5.7 |
| 16 In. (406.4 mm) | 1.4 | 3.6 | 5.0 | 1.4 | 6.1 | 7.5 |
| 20 In. (508 mm) | 1.7 | 4.5 | 6.2 | 1.7 | 7.7 | 9.4 |
| 24 In. (609.6 mm) | 2.0 | 5.4 | 7.4 | 2.0 | 9.3 | 11.3 |
| 28 In. (711.2 mm) | 2.4 | 6.2 | 8.6 | 2.4 | 10.8 | 13.2 |
| 32 In. (812.8 mm) | 2.7 | 7.2 | 9.9 | 2.7 | 12.4 | 15.1 |
| 36 In. (914.4 mm) | 3.1 | 8.0 | 11.1 | 3.1 | 13.9 | 17.0 |
| 40 In. (1016 mm) | 3.4 | 8.9 | 12.3 | 3.4 | 15.4 | 18.8 |
| 48 In. (1219 mm) | 4.1 | 14.7 | 18.8 | 4.1 | 18.5 | 22.6 |
| 60 In. (1524 mm) | — | — | — | 5.1 | 23.2 | 28.3 |

<http://www.rapidwelding.com>

| Wall Thickness | | | | | | | | |
|---|------|-------|-----------------|-------------|-------|--------------|-------------|-------|
| 5/8" (15.87 mm) | | | 3/4" (19.05 mm) | | | 1" (25.4 mm) | | |
| Electrode Required per Joint (lbs) ⁽¹⁾ | | | | | | | | |
| 3/32" | 1/8" | Total | 3/32" | 1/8 & 5/32" | Total | 3/32" | 1/8 & 5/32" | Total |
| .70 | 4.7 | 5.4 | | | | | | |
| 1.0 | 7.1 | 8.1 | 1.0 | 9.9 | 10.9 | 1.0 | 16.7 | 17.7 |
| 1.4 | 9.8 | 11.2 | 1.4 | 13.1 | 14.5 | 1.4 | 22.1 | 23.5 |
| 1.7 | 11.7 | 13.4 | 1.7 | 16.4 | 18.1 | 1.7 | 27.6 | 29.3 |
| 2.0 | 14.2 | 16.2 | 2.0 | 19.8 | 21.8 | 2.0 | 33.4 | 35.4 |
| 2.4 | 16.5 | 18.9 | 2.4 | 23.0 | 25.4 | 2.4 | 38.8 | 41.2 |
| 2.7 | 19.0 | 21.7 | 2.7 | 26.5 | 29.2 | 2.7 | 44.5 | 47.2 |
| 3.1 | 21.6 | 24.7 | 3.1 | 29.6 | 32.7 | 3.1 | 49.9 | 53.0 |
| 3.4 | 23.5 | 26.9 | 3.4 | 32.8 | 36.2 | 3.4 | 55.3 | 58.7 |
| 4.1 | 28.3 | 32.4 | 4.1 | 39.5 | 43.6 | 4.1 | 66.6 | 70.7 |
| 5.1 | 45.4 | 50.5 | 5.1 | 49.4 | 54.5 | 5.1 | 83.2 | 88.3 |

<http://www.rapidwelding.com>

| ASTM Spec | Description | Grades | Suggested Electrodes |
|------------------------------|--|---|--|
| A105 A161 | High Temp. Fittings Carbon Steel Still Tubes C-Mo Steel Still Tubes | I, II Low Carbon T1 | LH-78 (1), Excalibur 7018-1, LH-78, SA-85, Excalibur 7018-1, LH-78 |
| A178 A181 | Boiler Tubes | A C | (1), Excalibur 7018-1, LH-78 Excalibur 7018-1, LH-78 |
| A182 A199 A200 A209 | High Temp. Fittings, etc. Heat Exchanger Tubes Refinery Still Tubes C-Mo Boiler Tubes | F1 F2, F11, F12 T11 T1, T1a, T1b | SA-85, LH-7018-A1, LH-8018-B2 LH-90, LH-8018-B2 LH-8018-B2 LH-8018-B2 SA-85, Excalibur 7018-1, LH-78 |
| A210 A213 | Carbon Steel Boiler Tubes Boiler Tubes | A1 C T2 T11, T12, T17 | (1), 60XX, 70XX SA-85, Excalibur 7018-1, LH-78 LH-90, LH-8018-B2 LH-90, LH-8018-B2 |
| A216 A217 | High Temp. Cast Fittings High Temp. Cast Fittings | WC1 WC4, WC6 | Excalibur 7018-1 SA-85, LH-7018-A1 LH-90, LH-8018-B2 |
| A234 | Wrought Welding Fixtures | WPB, WPC WP1 WP11, WP12 | (1), LH-78 LH-7018-A1, SA-85, LH-90, LH-8018-B2 |

| ASTM Spec | Description | Grades | Suggested Electrodes |
|-------------------------|--|--|---|
| A250 A333 | C-Mn Tubes Low Temp. Pipe | T1, T1a, T1b 1, 6 7 | SA-85, LH-7018-A1 Excalibur 7018-1, LH-78, LH-7018-A1 LH-8018-C1 |
| A333 A335 | Low Temp. Pipe High Temp. Pipe | 1, 6 7 P1 P2, P11, P12 | LH-75, LH-78, LH-7018-A1 LH-8018-C1 LH-7018-A1 LH-90, LH-8018-B2 |
| A350 A369 | Low Temp. Fittings, etc. High Temp. Pipe | LF1, LF2 | Excalibur 7018-1, LH-78, LH-8018-C3 See A335 & A182 |
| A381 | High Pressure Pipe | Y35, Y42, Y46 Y52, Y56 Y60, Y65 P24 | (1), Excalibur 7018-1, LH-78 SA-HYP, SA-85, SA-70+, SA-80, Excalibur 7018-1, SA-HYP, SA-70+, SA-80 LH-9018-B3, LH-90 |
| A405 A420 | High Temp. Pipe Low Temp. Fittings | WPL6 | Excalibur 7018-1, LH-78, LH-8018-C3 |
| A420 A426 | Carbon Steel Tubes High Temp. Cast Pipe | 1 (1) 2 | LH-90, LH-8018-B2 LH-8018-C3 |
| A498 | Condenser Tubes | | See A335 See A199, A213, A334 |
| A500 A501 | Structural Tubing Structural Tubing | A, B, C | (1) (1) |
| A524 A556 | Seamless Carbon Steel Pipe Feedwater Heater Tubes | I, II A2 | (1) (1) |
| A557 A587 | | B2, C2 | Excalibur 7018-1, LH-78 |
| A595 A618 | Structural Structural Tubing | A, B | Excalibur 7018-1, LH-78 (1) Excalibur 7018-1, LH-78 |
| A660 A692 | Cast High Temp. Pipe Seamless Low-Alloy Tubes | WCA WCB, WCC | (1), Excalibur 7018-1, LH-78 Excalibur 7018-1, LH-78 SA-85, LH-7018-A1 |
| A694 A696 | Carbon & Alloy Steel Forgings Carbon Steel Bars | All | Excalibur 7018-1, LH-78, LH-8018-C3 Excalibur 7018-1, LH-78 |
| A699 A707 | Low Carbon Alloy Steel Plate, Shapes & Bars Carbon & Alloy Steel Flanges | L1, L2, L3 L4, L5, L6 | LH-90, LH-110M MR Excalibur 7018-1, LH-78, LH-8018-C3 LH-8018-C1 |
| A714 | Low Alloy Pipe | I, II, III IV V VI | Excalibur 7018-1, LH-78 LH-8018-C3 LH-8018-C1 LH-8018-C3 |
| A727 | Notch Tough Carbon Steel Forgings | | Excalibur 7018-1, LH-78 |



WARNING

ARC WELDING can be hazardous.

PROTECT YOURSELF AND OTHERS FROM POSSIBLE SERIOUS INJURY OR DEATH. KEEP CHILDREN AWAY. PACEMAKER WEARERS SHOULD CONSULT WITH THEIR DOCTOR BEFORE OPERATING.

Read and understand the following safety highlights. For additional safety information it is strongly recommended that you purchase a copy of "Safety in Welding & Cutting - ANSI Standard Z49.1" from the American Welding Society, P.O. Box 351040, Miami, Florida 33135 or CSA Standard W117.2-1974. A **Free** copy of "Arc Welding Safety" booklet E205 is available from the Lincoln Electric Company, 22801 St. Clair Avenue, Cleveland, Ohio 44117-1199.

BE SURE THAT ALL INSTALLATION, OPERATION, MAINTENANCE, AND REPAIR PROCEDURES ARE PERFORMED ONLY BY QUALIFIED INDIVIDUALS.



ELECTRIC SHOCK can kill.

1.a. The electrode and work (or ground) circuits are electrically "hot" when the welder is on. Do not touch these "hot" parts with your bare skin or wet clothing. Wear dry, hole-free gloves to insulate hands.

1.b. Insulate yourself from work and ground using dry insulation. Make certain the insulation is large enough to cover your full area of physical contact with work and ground.

In addition to the normal safety precautions, if welding must be performed under electrically hazardous conditions (in damp locations or while wearing wet clothing; on metal structures such as floors, gratings or scaffolds; when in cramped positions such as sitting, kneeling or lying, if there is a high risk of unavoidable or accidental contact with the workpiece or ground) use the following equipment:

- Semiautomatic DC Constant Voltage (Wire) Welder.
- DC Manual (Stick) Welder.
- AC Welder with Reduced Voltage Control.

1.c. In semiautomatic or automatic wire welding, the electrode, electrode reel, welding head, nozzle or semiautomatic welding gun are also electrically "hot".

1.d. Always be sure the work cable makes a good electrical connection with the metal being welded. The connection should be as close as possible to the area being welded.

1.e. Ground the work or metal to be welded to a good electrical (earth) ground.

1.f. Maintain the electrode holder, work clamp, welding cable and welding machine in good, safe operating condition. Replace damaged insulation.

1.g. Never dip the electrode in water for cooling.

1.h. Never simultaneously touch electrically "hot" parts of electrode holders connected to two welders because voltage between the two can be the total of the open circuit voltage of both welders.

1.i. When working above floor level, use a safety belt to protect yourself from a fall should you get a shock.

1.j. Also see Items 4.c. and 6.

ARC RAYS can burn.

2.a. Use a shield with the proper filter and cover plates to protect your eyes from sparks and the rays of the arc when welding or observing open arc welding. Headshield and filter lens should conform to ANSI Z87.1 standards.

2.b. Use suitable clothing made from durable flame-resistant material to protect your skin and that of your helpers from the arc rays.



FUMES AND GASES can be dangerous.

- 3.a. Welding may produce fumes and gases hazardous to health. Avoid breathing these fumes and gases. When welding, keep your head out of the fume. Use enough ventilation and/or exhaust at the arc to keep fumes and gases away from the breathing zone. **When welding with electrodes which require special ventilation such as stainless or hard facing (see instructions on container or MSDS) or on lead or cadmium plated steel and other metals or coatings which produce highly toxic fumes, keep exposure as low as possible and below Threshold Limit Values (TLV) using local exhaust or mechanical ventilation. In confined spaces or in some circumstances, outdoors, a respirator may be required. Additional precautions are also required when welding on galvanized steel.**
- 3.b. Do not weld in locations near chlorinated hydrocarbon vapors coming from degreasing, cleaning or spraying operations. The heat and rays of the arc can react with solvent vapors to form phosgene, a highly toxic gas, and other irritating products.
- 3.c. Shielding gases used for arc welding can displace air and cause injury or death. Always use enough ventilation, especially in confined areas, to insure breathing air is safe.
- 3.d. Read and understand the manufacturer's instructions for this equipment and the consumables to be used, including the material safety data sheet (MSDS) and follow your employer's safety practices. MSDS forms are available from your welding distributor or from the manufacturer.
- 3.e. Also see item 7b.

<http://www.rapidonlinetools.com>

- 4.e. Vent hollow castings or containers before heating, cutting or welding. They may explode.
- 4.f. Sparks and spatter are thrown from the welding arc. Wear oil free protective garments such as leather gloves, heavy shirt, cuffless trousers, high shoes and a cap over your hair. Wear ear plugs when welding out of position or in confined places. Always wear safety glasses with side shields when in a welding area.
- 4.g. Connect the work cable to the work as close to the welding area as practical. Work cables connected to the building framework or other locations away from the welding area increase the possibility of the welding current passing through lifting chains, crane cables or other alternate circuits. This can create fire hazards or overheat lifting chains or cables until they fail.
- 4.h. Also see item 7c.

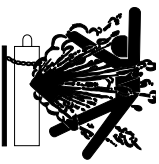

CYLINDER may explode if damaged.

5.a. Use only compressed gas cylinders containing the correct shielding gas for the process used and properly operating regulators designed for the gas and pressure used. All hoses, fittings, etc. should be suitable for the application and maintained in good condition.

5.b. Always keep cylinders in an upright position securely chained to an undercarriage or fixed support.

5.c. Cylinders should be located:

- Away from areas where they may be struck or subjected to physical damage.
- A safe distance from arc welding or cutting operations and any other source of heat, sparks, or flame.

5.d. Never allow the electrode, electrode holder or any other electrically "hot" parts to touch a cylinder.

5.e. Keep your head and face away from the cylinder valve outlet when opening the cylinder valve.

5.f. Valve protection caps should always be in place and hand tight except when the cylinder is in use or connected for use.

5.g. Read and follow the instructions on compressed gas cylinders, associated equipment, and CGA publication P-1, "Precautions for Safe Handling of Compressed Gases in Cylinders," available from the Compressed Gas Association 1235 Jefferson Davis Highway, Arlington, VA 22202.



FOR ENGINE powered equipment.

- 7.a Turn the engine off before troubleshooting and maintenance work unless the maintenance work requires it to be running.



7.b. Operate engines in open, well-ventilated areas or vent the engine exhaust fumes outdoors.

7.c. Do not add the fuel near an open flame welding arc or when the engine is running. Stop the engine and allow it to cool before refueling to prevent spilled fuel from vaporizing on contact with hot engine parts and igniting. Do not spill fuel when filling tank. If fuel is spilled, wipe it up and do not start engine until fumes have been eliminated.

7.d. Keep all equipment safety guards, covers and devices in position and in good repair. Keep hands, hair, clothing and tools away from V-belts, gears, fans and all other moving parts when starting, operating or repairing equipment.

7.e. In some cases it may be necessary to remove safety guards to perform required maintenance. Remove guards only when necessary and replace them when the maintenance requiring their removal is complete. Always use the greatest care when working near moving parts.

7.f. Do not put your hands near the engine fan. Do not attempt to override the governor or idler by pushing on the throttle control rods while the engine is running.

7.g. To prevent accidentally starting gasoline engines while turning the engine or welding generator during maintenance work, disconnect the spark plug wires, distributor cap or magneto wire as appropriate.

7.h. To avoid scalding, do not remove the radiator pressure cap when the engine is hot.

Apr. '93

Customer Assistance Policy

The business of The Lincoln Electric Company is manufacturing and selling high quality welding equipment, consumables, and cutting equipment. Our challenge is to meet the needs of our customers and to exceed their expectations. On occasion, purchasers may ask Lincoln Electric for advice or information about their use of our products. We respond to our customers based on the best information in our possession at that time. Lincoln Electric is not in a position to warrant or guarantee such advice, and assumes no liability, with respect to such information or advice. We expressly disclaim any warranty of any kind, including any warranty of fitness for any customer's particular purpose, with respect to such information or advice. As a matter of practical consideration, we also cannot assume any responsibility for updating or correcting any such information or advice once it has been given, nor does the provision of information or advice create, expand or alter any warranty with respect to the sale of our products.

Lincoln Electric is a responsive manufacturer, but the selection and use of specific products sold by Lincoln Electric is solely within the control of, and remains the sole responsibility of the customer. Many variables beyond the control of Lincoln Electric affect the results obtained in applying this type of fabrication methods and service requirements.

LINCOLN[®]
ELECTRIC

THE WELDING EXPERTS

THE LINCOLN ELECTRIC COMPANY

22801 Saint Clair Ave.
Cleveland, Ohio 44117-1199

TEL: 216.481.8100 • FAX: 216.486.1751

www.lincolnelectric.com

Stick
C2.420 10/02